

Snake - satin - HO 150mA - RAL
06.48000554-9999

Fixture details

Mounting	Wall
Light emission	Direct
Fitting cover	satin diffusor
Protection rate	IP 20
Housing	Aluminium
Finish	RAL colour at your choice
Certificates	CE, ISO 9001



Electric details

Protection class	I
Supply	230V
Control gear box	Current driver

Lamp details

Lamptype	LED 4000K
Wattage	3,2W
Gross luminous flux	3350
Luminaire power	17,6W
Number	5
Lifetime LED module	L80/B10 > 72000h
Color tolerance	MacAdam 3
CRI	>80

Photometric details

UGR	>19
CIE Fluxcode	43 73 91 95 79

Dimensions

A	1790 mm
---	---------

Remarks

Wall luminaire - Direct - HO 150mA satin - RAL

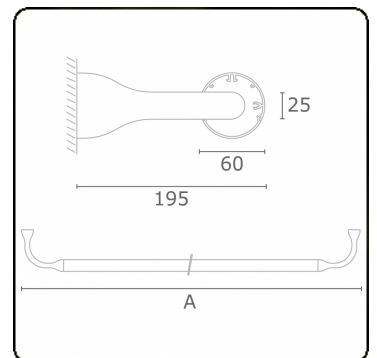

ENERGY

Verrijgbaar op aanvraag.

Disponible sur demande.

Available on request.

Auf Anfrage.

WXYZ
kWh/1000h

MULTILINE®

2019/2015