

Rekta 65x90 Direct/Indirect - VDT - HO 150mA - RAL  
04.94320583-9999

**Fixture details**

Mounting	Pendant
Light emission	Direct-Indirect
Fitting cover	VDT louvre
Protection rate	IP 20
Housing	Aluminium
Finish	RAL colour at your choice
Certificates	CE, ISO 9001

**Electric details**

Protection class	I
Supply	230V
Control gear box	Current driver

**Lamp details**

Lamptype	LED 3000K
Wattage	3,2W
Gross luminous flux	9525
Luminaire power	52,7W
Number	15
Lifetime LED module	L80/B10 > 72000h
Color tolerance	MacAdam 3
CRI	>80

**Photometric details**

UGR	<19
CIE Fluxcode	80 99 100 100 76
CIE Fluxcode Indirect	00 00 00 00 67

**Dimensions**

A	2250 mm
---	---------

**Remarks**

Suspended luminaire - Direct/Indirect - HO 150mA - VDT - RAL

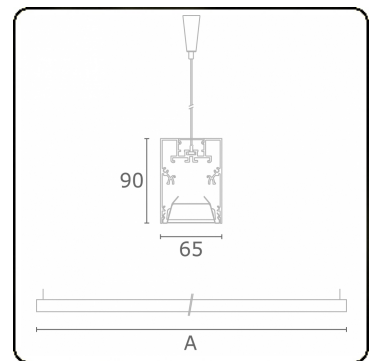

**ENERGY**

Verrijgbaar op aanvraag.

Disponible sur demande.

Available on request.

Auf Anfrage.

**WXYZ**  
kWh/1000h

**MULTILINE®**

2019/2015

