

Re-LED Direct/Indirect satin - HO 225mA - RAL
04.91104844-9999

Fixture details

Mounting	Pendant
Light emission	Direct-Indirect
Fitting cover	satin diffusor
Protection rate	IP 20
Housing	Aluminium
Finish	RAL colour at your choice
Certificates	CE, ISO 9001

Electric details

Protection class	I
Supply	230V
Control gear box	Current driver DALI/TD

Lamp details

Lamptype	LED 4000K
Wattage	6,7W
Gross luminous flux	10980
Luminaire power	60,9W
Number	4
Lifetime LED module	L80/B10 > 72000h
Color tolerance	MacAdam 3
CRI	>80 + 4x LED 4000K 7,1W

Photometric details

UGR	>19
CIE Fluxcode	49 80 96 99 70
CIE Fluxcode Indirect	00 00 00 00 73

Dimensions

A	1178 mm
---	---------

Remarks

Suspended luminaire - Direct - HO 225mA - satin (flush) - RAL

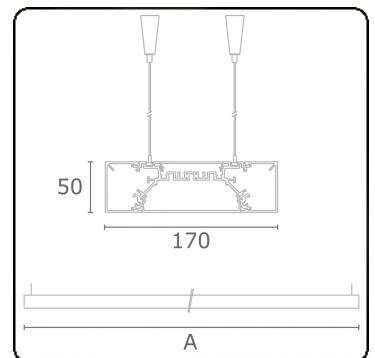

ENERGY

Verkrijgbaar op aanvraag.

Disponible sur demande.

Available on request.

Auf Anfrage.

WXYZ
kWh/1000h

MULTILINE®

2019/2015