

Tube 70 T1 - satin - HO 150mA - double cable gland  
35.90214533-0000

**Fixture details**

Mounting	Wall
Light emission	Direct
Fitting cover	satin diffusor
Protection rate	IP 65
Housing	Polycarbonate/PMMA
Finish	frosted
Certificates	CE, ISO 9001

**Electric details**

Protection class	I
Supply	230V
Control gear box	Current driver DALI/TD

**Lamp details**

Lamptype	LED 3000K
Wattage	3,2W
Gross luminous flux	1905
Luminaire power	10,5W
Number	3
Lifetime LED module	L80/B10 > 72000h
Color tolerance	MacAdam 3
CRI	>80

**Photometric details**

CIE Fluxcode	45 74 91 93 85
--------------	----------------

**Dimensions**

A	920 mm
---	--------

**Remarks**

Wall luminaire - satin - HO 150mA - double cable gland

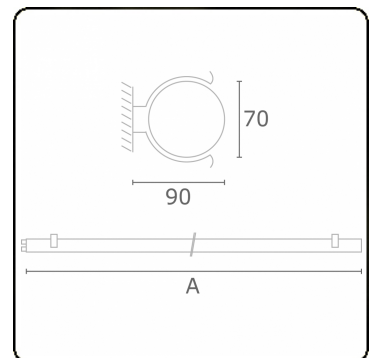

**ENERGY**

Verkrijgbaar op aanvraag.

Disponible sur demande.

Available on request.

Auf Anfrage.

**WXYZ**  
kWh/1000h

**MULTILINE®**

2019/2015