

Tube 70 T1 - satin - HO 150mA - double cable gland
35.90210524-0000

Fixture details

Mounting	Wall
Light emission	Diffus
Fitting cover	satin diffusor
Protection rate	IP 65
Housing	Polycarbonate/PMMA
Finish	frosted
Certificates	CE, ISO 9001

Electric details

Protection class	I
Supply	230V
Control gear box	Current driver

Lamp details

Lamptype	LED 4000K
Wattage	3,2W
Gross luminous flux	1340
Luminaire power	7,0W
Number	2
Lifetime LED module	L80/B10 > 72000h
Color tolerance	MacAdam 3
CRI	>80

Photometric details

CIE Fluxcode	45 74 91 93 85
--------------	----------------

Dimensions

A	640 mm
---	--------

Remarks

Wall luminaire - satin - HO 150mA - double cable gland

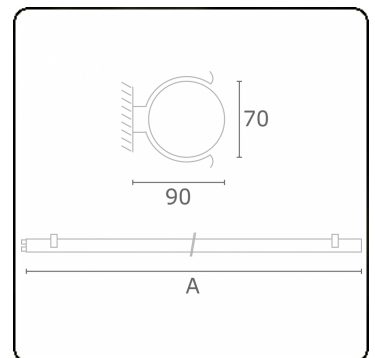

ENERGY

Verrijgbaar op aanvraag.

Disponible sur demande.

Available on request.

Auf Anfrage.

WXYZ
kWh/1000h

MULTILINE®

2019/2015