

Edge 55 S Direct - MPO - HO 150mA - ANO  
07.74010584-0001

**Fixture details**

Mounting	Ceiling recessed
Light emission	Direct
Fitting cover	micro prismatic diffuser
Protection rate	IP 20
Housing	Aluminium
Finish	anodized finish
Certificates	CE, ISO 9001



**Electric details**

Protection class	I
Supply	230V
Control gear box	Current driver

**Lamp details**

Lamptype	LED 4000K
Wattage	3,2W
Gross luminous flux	5400
Luminaire power	28,1W
Number	8
Lifetime LED module	L80/B10 > 72000h
Color tolerance	MacAdam 3
CRI	>80

**Photometric details**

UGR	>19
CIE Fluxcode	58 89 98 100 50

**Dimensions**

A	2256 mm
---	---------

**Remarks**

Recessed luminaire (trimless) - Direct - HO 150mA - MPO - ANO

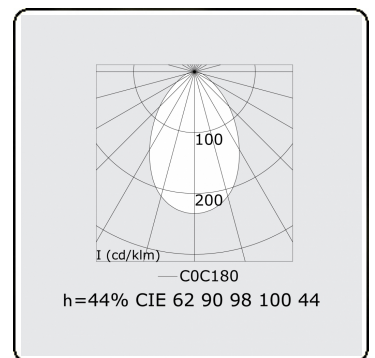
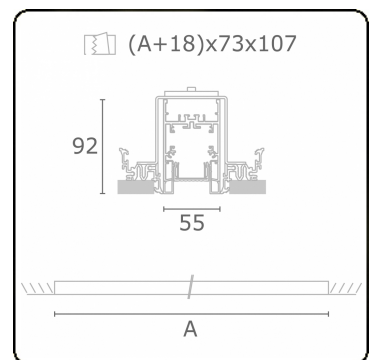

**ENERGY**

A  
 Verkrijgbaar op aanvraag.  
B  
 Disponible sur demande.  
C  
D  
 Available on request.  
E  
F  
 Auf Anfrage.  
G

**WXYZ**  
kWh/1000h

**MULTILINE®** 2019/2015