

Hideline 65x90 Direct/Indirect - VDT - LO 400mA - RAL
04.70320173-9999

Fixture details

Mounting	Pendant
Light emission	Direct-Indirect
Fitting cover	VDT louvre
Protection rate	IP 20
Housing	Aluminium
Finish	RAL colour at your choice
Certificates	CE, ISO 9001

Electric details

Protection class	I
Supply	230V
Control gear box	Current driver

Lamp details

Lamptype	LED 3000K
Wattage	4,5W
Gross luminous flux	10140
Luminaire power	64,4W
Number	13
Lifetime LED module	L80/B10 > 72000h
Color tolerance	MacAdam 3
CRI	>80

Photometric details

UGR	<19
CIE Fluxcode	90 99 100 100 68
CIE Fluxcode Indirect	00 00 00 00 67

Dimensions

A	1970 mm
---	---------

Remarks

Suspended luminaire - Direct/Indirect - LO 400mA - VDT louvre - RAL

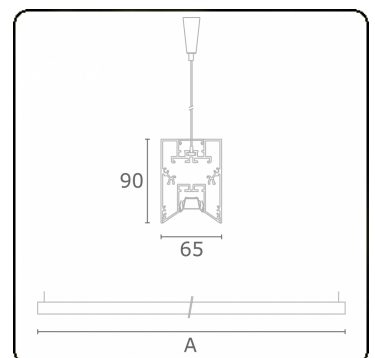

ENERGY

Verkrijgbaar op aanvraag.

Disponible sur demande.

Available on request.

Auf Anfrage.

WXYZ
kWh/1000h

MULTILINE®

2019/2015