

Rekta 30x90 Direct - VDT - LO 400mA - RAL  
04.13420173-9999

**Fixture details**

Mounting	Pendant
Light emission	Direct
Fitting cover	VDT louvre
Protection rate	IP 20
Housing	Aluminium
Finish	RAL colour at your choice
Certificates	CE, ISO 9001

**Electric details**

Protection class	I
Supply	230V
Control gear box	Current driver

**Lamp details**

Lamptype	LED 3000K
Wattage	4,4W
Gross luminous flux	5740
Luminaire power	34,3W
Number	7
Lifetime LED module	L80/B10 > 72000h
Color tolerance	MacAdam 3
CRI	>80

**Photometric details**

UGR	<19
CIE Fluxcode	90 99 100 100 68

**Dimensions**

A	1970 mm
---	---------

**Remarks**

Suspended luminaire - Direct - LO 400mA - VDT louvre - RAL

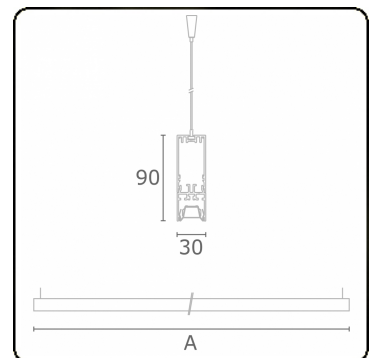

**ENERGY**

Verrijgbaar op aanvraag.

Disponible sur demande.

Available on request.

Auf Anfrage.

**WXYZ**  
kWh/1000h

**MULTILINE®**

2019/2015