

Rekta 40x70 Direct - satin - HO 150mA - ANO  
07.09200553-0001

**Fixture details**

Mounting	Ceiling recessed
Light emission	Direct
Fitting cover	satin diffusor
Protection rate	IP 20
Housing	Aluminium
Finish	anodized finish
Certificates	CE, ISO 9001



**Electric details**

Protection class	I
Supply	230V
Control gear box	Current driver

**Lamp details**

Lamptype	LED 3000K
Wattage	3,2W
Gross luminous flux	3175
Luminaire power	17,6W
Number	5
Lifetime LED module	L80/B10 > 72000h
Color tolerance	MacAdam 3
CRI	>80

**Photometric details**

UGR	>19
CIE Fluxcode	49 80 96 100 66

**Dimensions**

A	1404 mm
---	---------

**Remarks**

Recessed luminaire (trimless) - Direct - HO 150mA - satin (flush) - ANO

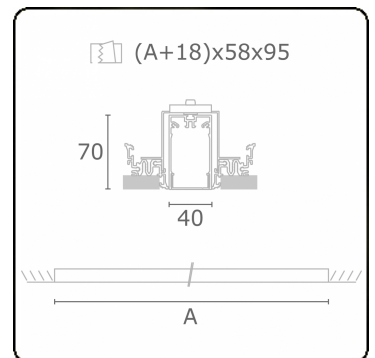

**ENERGY**

Verrijgbaar op aanvraag.

Disponible sur demande.

Available on request.

Auf Anfrage.

**MULTILINE®** **WXYZ**  
kWh/1000h

2019/2015