

Lining Direct/Indirect - satiné - HO 225mA - ANO
04.84104864-0001

Armatuurgegevens

Montage	Gependeld
Lichtuittreding	Direct-Indirect
Afscherming	satiné plexi
Beschermingsgraad	IP 20
Behuizing	Aluminium
Afwerking	geanodiseerde afwerking
Keurmerken	CE, ISO 9001

Elektrische Gegevens

Veiligheidsklasse	I
Voeding	230V
Voorschakelapparaat	Stroomvoeding DALI/TD

Lampgegevens

Lamptype	LED 4000K
Wattage	6,7W
Bruto lichtstroom	16470
Armatuur vermogen	91,4W
Aantal	6
Levensduur LED module	L80/B10 > 72000h
Kleurtolerantie	MacAdam 3
CRI	>80 + 6x LED 4000K 7,1W

Lichttechnische gegevens

UGR	>19
CIE Fluxcode	49 80 96 99 65
CIE Fluxcode Indirect	00 00 00 00 73

Afmetingen

A	1750 mm
B	60 mm
C	200 mm

Opmerkingen

Pendelarmatuur - Direct - HO 225mA - satiné (gelijkglegend) - ANO

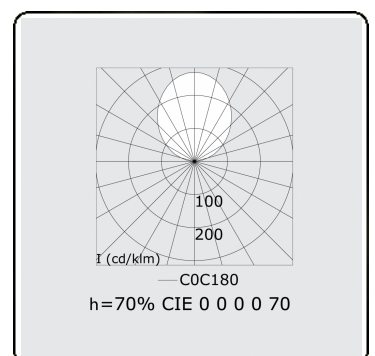
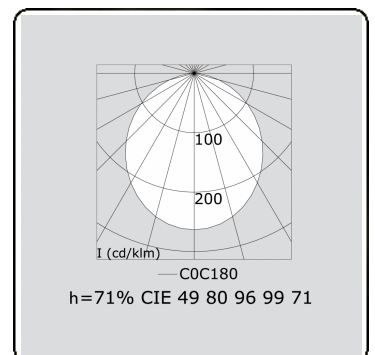
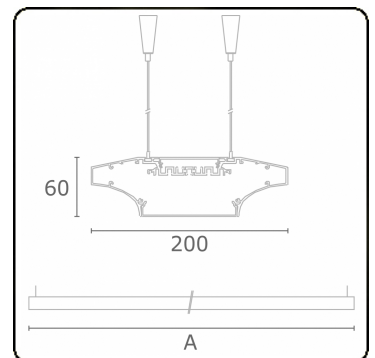

ENERGY

Verkrijgbaar op aanvraag.

Disponible sur demande.

Available on request.

Auf Anfrage.

WXYZ
kWh/1000h

MULTILINE®

2019/2015