

Anilo Direct/Indirect - satin - MO - RAL 9006
04.49102173-9006

Fixture details

Mounting	Pendant
Light emission	Direct-Indirect
Fitting cover	Opal diffuser
Protection rate	IP 20
Housing	Aluminium
Finish	RAL 9006 White aluminium
Certificates	CE, ISO 9001



Electric details

Protection class	I
Supply	230V
Control gear box	Current driver 1-10V

Lamp details

Lamptype	LED 3000K
Wattage	381W
Luminaire power	381W
Luminaire luminous flux	41262
Number	1
Lifetime LED module	L80/B10 = 50000h
Color tolerance	MacAdam 3
CRI	>80

Photometric details

UGR	>19
CIE Fluxcode	47 78 95 36 100

Dimensions

A	4000 mm
---	---------

Remarks

Suspended luminaire - Direct/Indirect - satin - MO - RAL 9006

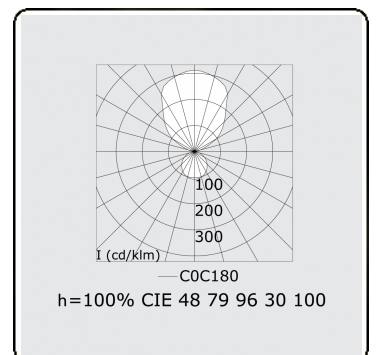
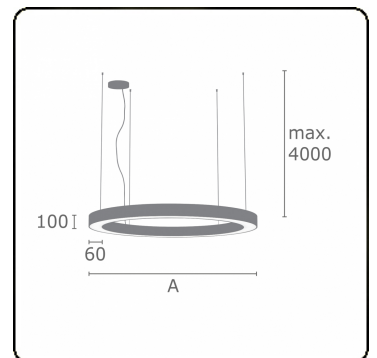

ENERGY

Verrijgbaar op aanvraag.

Disponible sur demande.

Available on request.

Auf Anfrage.

WXYZ
kWh/1000h

MULTILINE®

2019/2015