

Anilo Direct - satin - MO - RAL 9005
04.49006124-9005

Fixture details

Mounting	Pendant
Light emission	Direct
Fitting cover	Opal diffuser
Protection rate	IP 20
Housing	Aluminium
Finish	RAL 9005 Jet black
Certificates	CE, ISO 9001



Electric details

Protection class	I
Supply	230V
Control gear box	Power supply touch-dim

Lamp details

Lamptype	LED 4000K
Wattage	50W
Luminaire power	50W
Luminaire luminous flux	4420
Number	1
Lifetime LED module	L80/B10 = 50000h
Color tolerance	MacAdam 3
CRI	>80

Photometric details

UGR	>19
CIE Fluxcode	47 78 95 100 100

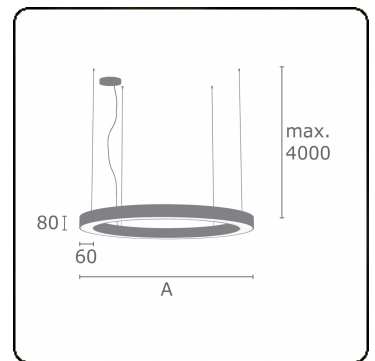

Dimensions

A	1200 mm
---	---------

Remarks

Suspended luminaire - Direct - satin - MO - RAL 9005

ENERGY

Verrijgbaar op aanvraag.

Disponible sur demande.

Available on request.

Auf Anfrage.

WXYZ
kWh/1000h

MULTILINE®

2019/2015