

Anilo Direct - satin - MO - RAL 9003  
04.49006184-9003

**Fixture details**

Mounting	Pendant
Light emission	Direct
Fitting cover	Opal diffuser
Protection rate	IP 20
Housing	Aluminium
Finish	RAL 9003 Signal white
Certificates	CE, ISO 9001

**Electric details**

Protection class	I
Supply	230V
Control gear box	Power supply touch-dim

**Lamp details**

Lamptype	LED 4000K
Wattage	221W
Luminaire power	221W
Luminaire luminous flux	18130
Number	1
Lifetime LED module	L80/B10 = 50000h
Color tolerance	MacAdam 3
CRI	>80

**Photometric details**

UGR	>19
CIE Fluxcode	47 78 95 100 100

**Dimensions**

A	5000 mm
---	---------

**Remarks**

Suspended luminaire - Direct - satin - MO - RAL 9003

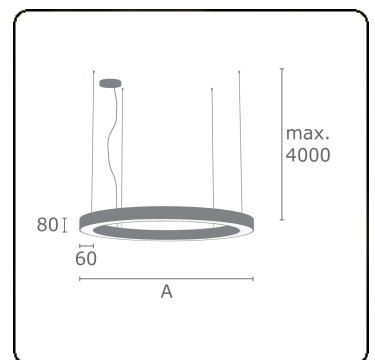

**ENERGY**

Verrijgbaar op aanvraag.

Disponible sur demande.

Available on request.

Auf Anfrage.

**WXYZ**  
kWh/1000h

**MULTILINE®**

2019/2015