

Edge 55 B Direct - satiné - HO 150mA - RAL  
04.74200574-9999

**Armatuurgegevens**

Montage	Gependeld
Lichtuittreding	Direct
Afscherming	satiné plexi
Beschermingsgraad	IP 20
Behuizing	Aluminium
Afwerking	RAL kleur naar keuze
Keurmerken	CE, ISO 9001



**Elektrische Gegevens**

Veiligheidsklasse	I
Voeding	230V
Voorschakelapparaat	Stroomvoeding

**Lampgegevens**

Lamptype	LED 4000K
Wattage	3,2W
Bruto lichtstroom	4690
Armatuur vermogen	24,6W
Aantal	7
Levensduur LED module	L80/B10 > 72000h
Kleurtolerantie	MacAdam 3
CRI	>80

**Lichttechnische gegevens**

UGR	>19
CIE Fluxcode	56 87 99 99 59

**Afmetingen**

A	1976 mm
---	---------

**Opmerkingen**

Pendelarmatuur - Direct - HO 150mA - satiné - RAL

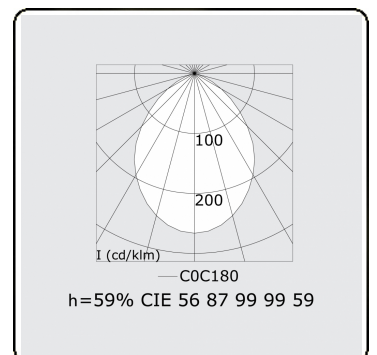
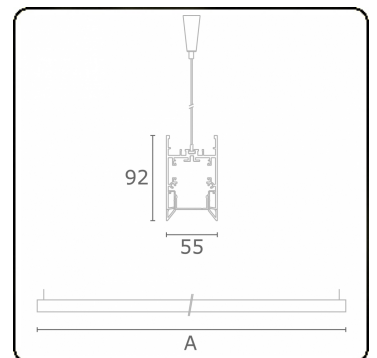

**ENERGY**

Verrijgbaar op aanvraag.

Disponible sur demande.

Available on request.

Auf Anfrage.

**WXYZ**  
kWh/1000h

**MULTILINE®** 2019/2015