

Edge 55 S Direct - MPO - HO 150mA - ANO
07.74014574-0001

Fixture details

Mounting	Ceiling recessed
Light emission	Direct
Fitting cover	micro prismatic diffuser
Protection rate	IP 20
Housing	Aluminium
Finish	anodized finish
Certificates	CE, ISO 9001



Electric details

Protection class	I
Supply	230V
Control gear box	Current driver DALI/TD

Lamp details

Lamptype	LED 4000K
Wattage	3,2W
Gross luminous flux	4690
Luminaire power	24,6W
Number	7
Lifetime LED module	L80/B10 > 72000h
Color tolerance	MacAdam 3
CRI	>80

Photometric details

UGR	>19
CIE Fluxcode	58 89 98 100 50

Dimensions

A	1976 mm
---	---------

Remarks

Recessed luminaire (trimless) - Direct - HO 150mA - MPO - ANO

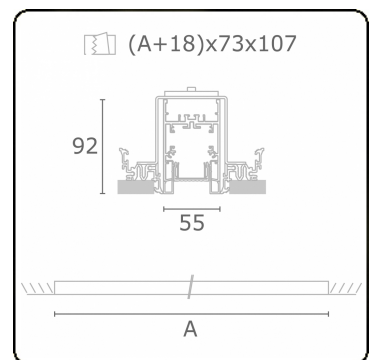

ENERGY

Verrijgbaar op aanvraag.

Disponible sur demande.

Available on request.

Auf Anfrage.

WXYZ
kWh/1000h

MULTILINE®

2019/2015