

Nhua - satiné - HO 150mA - ANO  
04.19000544-0001

**Armatuurgegevens**

Montage	Gependeld
Lichtuittreding	Direct-Indirect
Afscherming	satiné plexi
Beschermingsgraad	IP 40
Behuizing	Aluminium
Afwerking	geanodiseerde afwerking
Keurmerken	CE, ISO 9001

**Elektrische Gegevens**

Veiligheidsklasse	I
Voeding	230V
Voorschakelapparaat	Stroomvoeding

**Lampgegevens**

Lamptype	LED 4000K
Wattage	3,2W
Bruto lichtstroom	2680
Armatuur vermogen	14,1W
Aantal	4
Levensduur LED module	L80/B10 > 72000h
Kleurtolerantie	MacAdam 3
CRI	>80

**Lichttechnische gegevens**

UGR	>19
CIE Fluxcode	34 61 83 76 75

**Afmetingen**

A	1134 mm
---	---------

**Opmerkingen**

Pendelarmatuur - HO 150mA - satiné - ANO

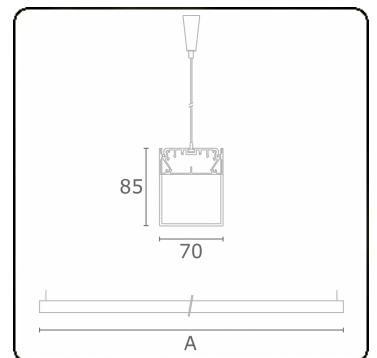

**ENERGY**

Verrijgbaar op aanvraag.

Disponible sur demande.

Available on request.

Auf Anfrage.

**WXYZ**  
kWh/1000h

**MULTILINE®**

2019/2015