

T-Line 130 - Direct or Indirect - curved cover panel - ANO
06.37200044-0001

Fixture details

Mounting	Wall
Light emission	Direct or Indirect
Fitting cover	Prismatic diffuser
Protection rate	IP 20
Housing	Aluminium/Polycarbonate
Finish	anodized finish
Certificates	CE, ISO 9001



Electric details

Protection class	I
Supply	230V
Control gear box	Current driver

Lamp details

Lamptype	LED 4000K
Wattage	3,6W
Gross luminous flux	2680
Luminaire power	15,8W
Number	4
Lifetime LED module	L80/B10 > 72000h
Color tolerance	MacAdam 3
CRI	>80

Photometric details

CIE Fluxcode	70 93 99 100 71
CIE Fluxcode Indirect	00 00 00 00 71

Dimensions

A	1154 mm
---	---------

Remarks

direct or indirect light distribution with curved cover

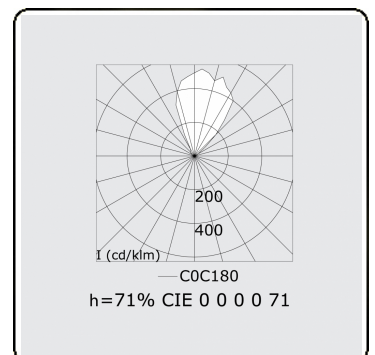
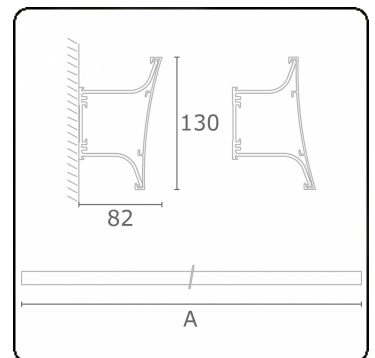

ENERGY

Verrijgbaar op aanvraag.

Disponible sur demande.

Available on request.

Auf Anfrage.

WXYZ
kWh/1000h

MULTILINE®

2019/2015