

Focus 1.1
05.081044-9999

Armatuurgegevens

Montage	Plafond
Lichtuittreding	Spot
Beschermingsgraad	IP 20
Behuizing	Aluminium
Afwerking	RAL kleur naar keuze
Keurmerken	CE, ISO 9001

Elektrische Gegevens

Veiligheidsklasse	I
Voeding	230V
Voorschakelapparaat	Stroomvoeding

Lampgegevens

Lamptype	LED 4000K 8°
Wattage	4x1W
Bruto lichtstroom	532
Armatuur vermogen	5,9W
Aantal	1
Levensduur LED module	L70/B50 > 60000h
Kleurtolerantie	MacAdam 3
CRI	80

Lichttechnische gegevens

UGR	<19
CIE Fluxcode	95 97 99 100 87

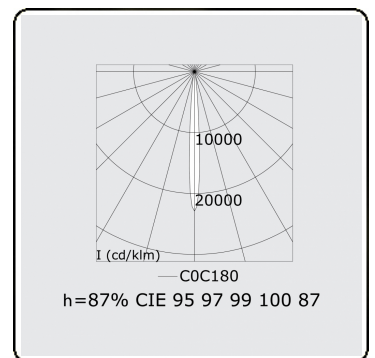
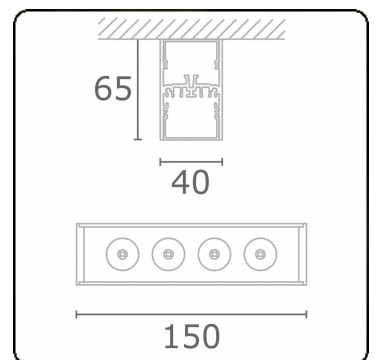

ENERGY

Verkrijgbaar op aanvraag.

Disponible sur demande.

Available on request.

Auf Anfrage.

WXYZ
kWh/1000h

MULTILINE®

2019/2015