

Focus 1.1
05.082043-9999

Fixture details

Mounting	Ceiling
Light emission	Spotlight
Protection rate	IP 20
Housing	Aluminium
Finish	RAL colour at your choice
Certificates	CE, ISO 9001

Electric details

Protection class	I
Supply	230V
Control gear box	Current driver

Lamp details

Lamptype	LED 3000K 32°
Wattage	4x1W
Gross luminous flux	504
Luminaire power	5,9W
Number	1
Lifetime LED module	L70/B50 > 60000h
Color tolerance	MacAdam 3
CRI	80

Photometric details

UGR	<19
CIE Fluxcode	96 99 100 100 85

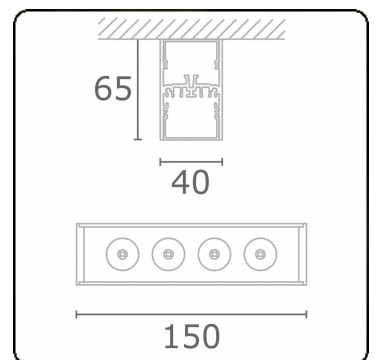

ENERGY

Verrijgbaar op aanvraag.

Disponible sur demande.

Available on request.

Auf Anfrage.

WXYZ
kWh/1000h

MULTILINE®

2019/2015